

TECHNICAL DATA SERIES 85

MODEL		VB190	
MAX WORKING TORQUE (Nm)		190	
NOMINAL TENSION (V)	LOW VOLTAGE	12V AC/DC	
		24V AC/DC	
	MULTIVOLTAGE	100-240V AC	
WORKING TIME (sec)		27	
TORQUE LIMITER		STD	
DUTY RATING	12V AC/DC	50%	
	24V AC/DC	75%	
	100-240V AC		
PROTECTION		IP67	
ENCLOSURE		TECHNOPOLYMER	
ROTATION		90°	
UPON REQUEST ROTATION		180° or 270°	
MANUAL OVERRIDE		STD	
POSITION INDICATOR		STD	
WORKING TEMPERATURE		-20°C + 55°C	
HEATER		STD	
ADDITIONAL FREE LIMIT SWITCHES		n°2 STD (type SPDT)	
DRILLING ISO 5211		F07 - F10	
SQUARE (mm)		17	
SQUARE UPON REQUEST (mm)		22-14	
FAIL-SAFE OPERATION (BATTERY BACKUP)		UPON REQUEST	NOT AVAIABLE FOR MOD. 12V
STD (4~20mA or 0~10 VDC) REVERSE (20~4mA or 10~0 VDC) MODE POSITIONER		UPON REQUEST	
MIDDLE POSITION		UPON REQUEST	
ROTARY POTENTIOMETER (5K \hat{I} © 1W)		UPON REQUEST	
ELECTRICAL CONNECTIONS		PG11	
WEIGHT (Kg)		4,90	

ELECTRIC ACTUATOR CONSUMPTION DATA

MODEL		VB190	
VERSION H	NOMINAL VOLTAGE	100-240V AC	
	ABSORBED CURRENT	0,6-0,3 A	
	ABSORBED POWER	60-72 VA	
VERSION L	NOMINAL VOLTAGE	12V AC/DC	24V AC/DC
	ABSORBED CURRENT	3,8-2,85 A	1,8-1,2 A
	ABSORBED POWER	46-34 VA	43-29 VA
FREQUENCY		50/60 HZ	

MOD. VB190

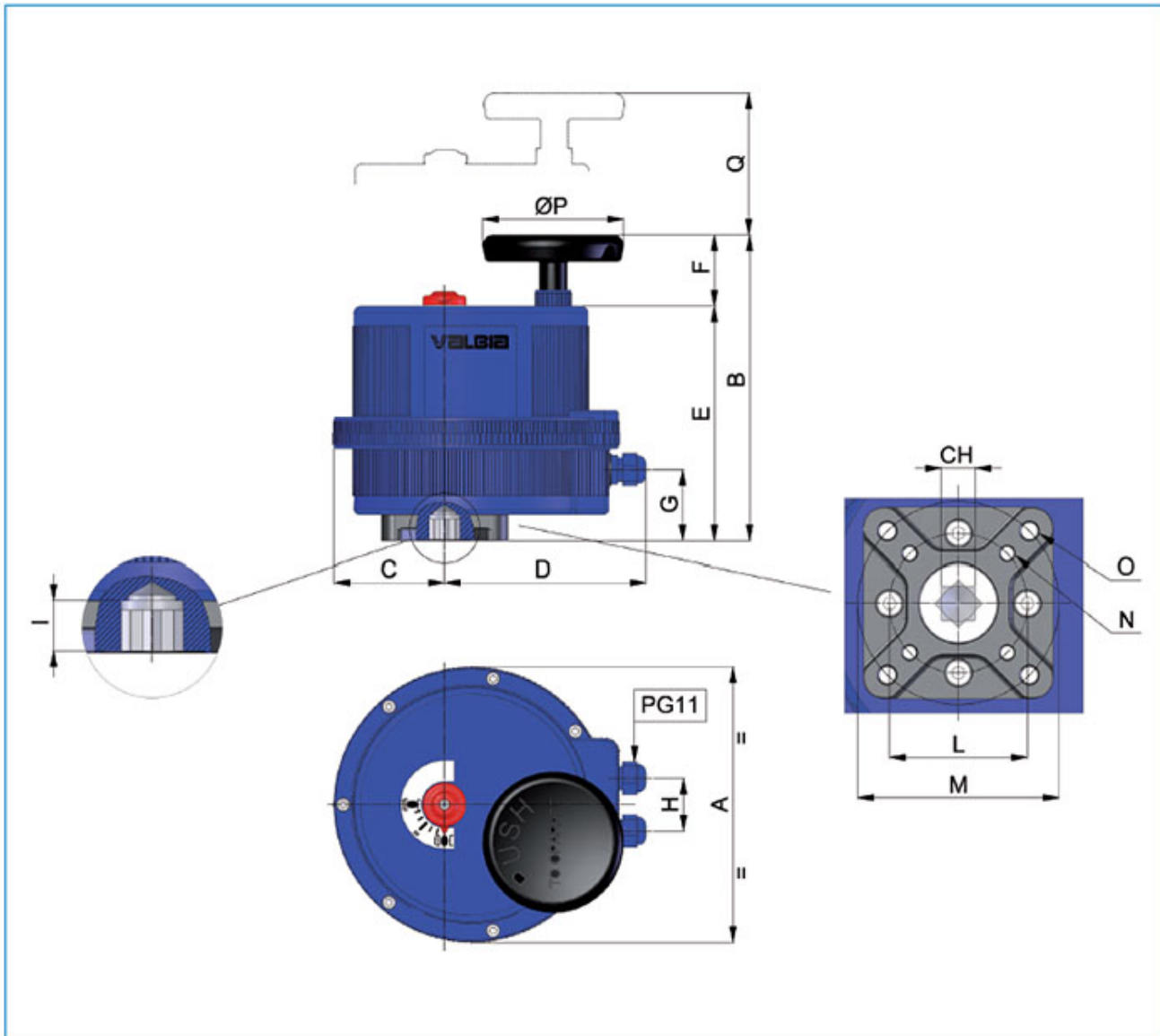

MOD.	DRILLING ISO 5211	CH	A	B	C	D	E	F	G	H	I	L	M	N	O	âP.	Q
VB190	F07-F10	17	211	232,1	84	153	178	54,1	54	40	19	70	102	M8X20	M10X20	110	115

ELECTRIC WIRING VB190 12V AC/DC 50/60 Hz, 24V AC/DC 50/60 Hz, 100-240V AC 50/60 Hz

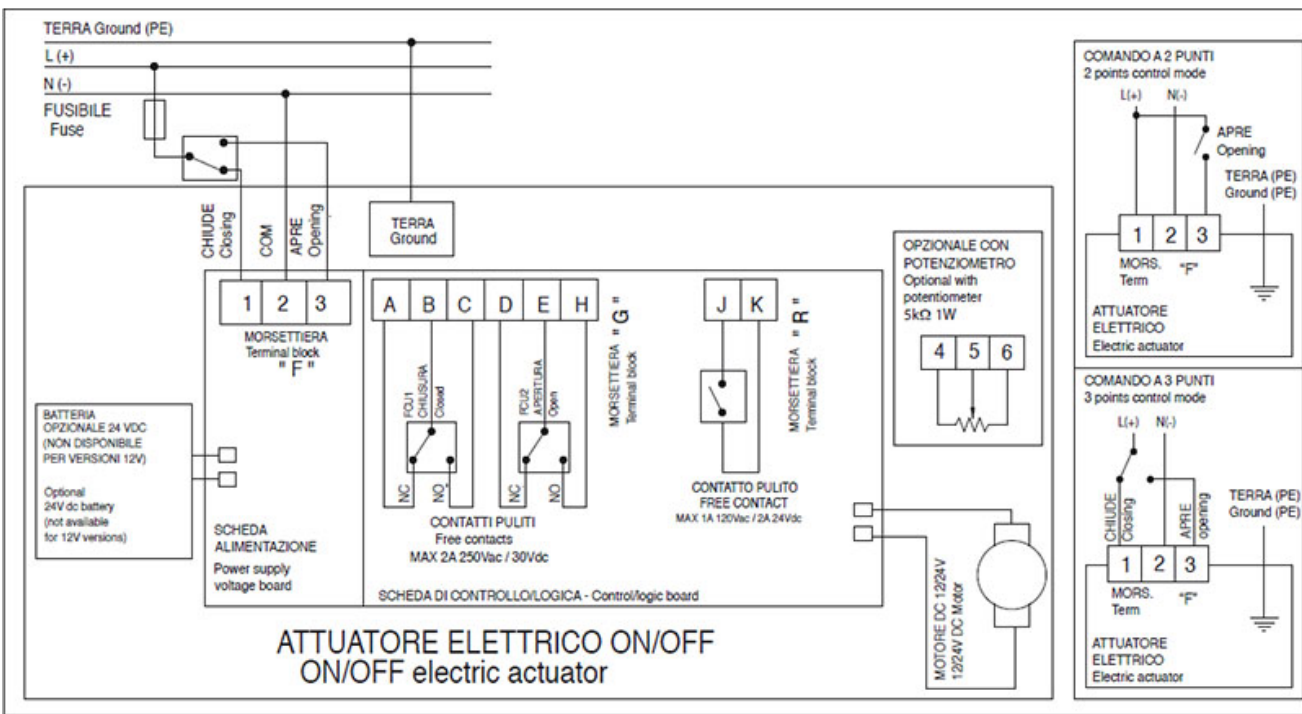

ELECTRIC WIRING WITH POSITIONER VB190 12V-24V AC/DC 50/60 HZ 12V AC/DC 50/60 Hz, 24V AC/DC 50/60 Hz, 100-240V AC 50/60 Hz

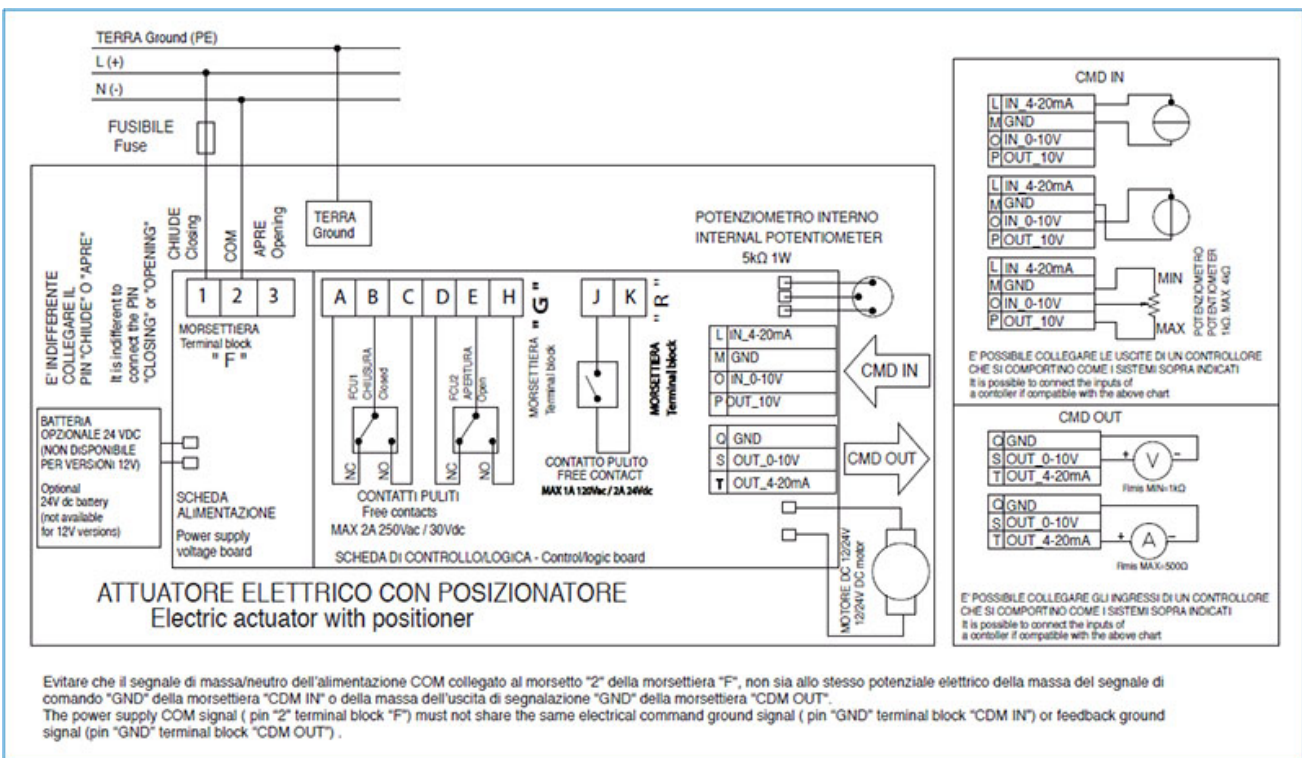

ELECTRIC WIRING WITH MIDDLE POSITION VB190 12V AC/DC 50/60 Hz, 24V AC/DC 50/60 Hz, 100-240V AC 50/60 Hz

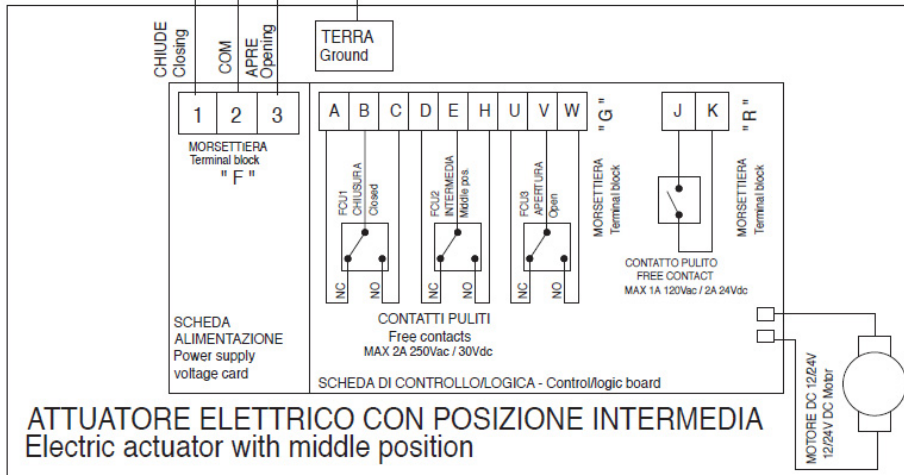
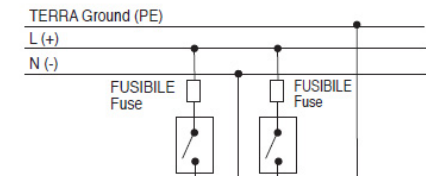

ATTUATORE ELETTRICO CON POSIZIONE INTERMEDIA
Electric actuator with middle position

COMANDO ATTUATORE
Electric actuator

	SW1 CHIUSO/Closed	SW1 APERTO/Open
SW2 APERTO/Open	CHIUSURA Closing	-
SW2 CHIUSO/Closed	POS. INTERMEDIA Middle position	APERTURA Opening

