

# Series PR precision regulators with manual override

Size 1 ports: G1/4  
Size 2 ports: G1/4, G3/8



- » High precision adjustment
- » Multi-diaphragm construction to reach the highest stability
- » Adjustment lock
- » Compact dimensions
- » Removable adjustment knob

The Series PR precision pressure regulators are ideal for applications that require a precise and stable air pressure control. The operating principle using multiple diaphragms allows the Series PR to react to even the smallest pressure variations that may occur during use.

## GENERAL DATA

<b>Construction</b>	compact, multi-diaphragm type
<b>Materials</b>	see the following page
<b>Ports</b>	Size 1: G1/4 Size 2: G1/4, G3/8
<b>Mounting</b>	vertical in-line, wall or panel mounting (in any position)
<b>Working temperature</b>	0°C ÷ 50°C
<b>Inlet pressure</b>	0.1 ÷ 12 bar
<b>Outlet pressure</b>	0.05 ÷ 2 bar 0.05 ÷ 4 bar 0.05 ÷ 7 bar 0.05 ÷ 10 bar
<b>Overpressure exhaust</b>	with relieving (standard)
<b>Nominal flow</b>	see FLOW DIAGRAMS on the following pages
<b>Media</b>	filtered and not lubricated compressed air according to DIN ISO 8573-1 Classes 1-3-2
<b>Hysteresis</b>	20mbar
<b>Repeatability</b>	±0.2% FS
<b>Bleed air consumption</b>	≤ 5 l/min

**CODING EXAMPLE**

<b>PR</b>	<b>1</b>	<b>04</b>	<b>-</b>	<b>M</b>	<b>07</b>
<b>PR</b>	SERIES				
<b>1</b>	SIZE: 1 = size 1 2 = size 2				
<b>04</b>	PORTS: 04 = G1/4 38 = G3/8 (size 2 only)				
<b>M</b>	TYPE OF ADJUSTMENT: M = manual				
<b>07</b>	OPERATING PRESSURE (1 bar = 14,5 psi): 02 = 0.05 ÷ 2 bar 04 = 0.05 ÷ 4 bar 07 = 0.05 ÷ 7 bar 00 = 0.05 ÷ 10 bar				

SERIES PR PRECISION REGULATORS

**Series PR precision regulators - materials**

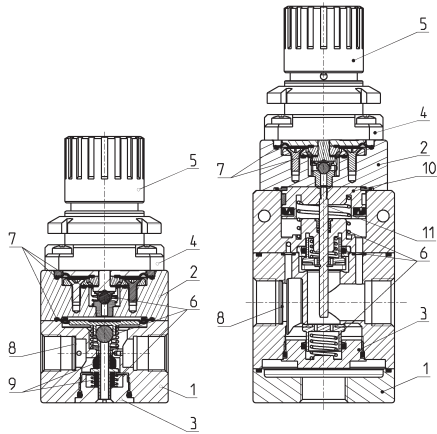

PARTS	MATERIALS
<b>1 = Body</b>	Anodized aluminium
<b>2 = Intermediate body</b>	Aluminium
<b>3 = Valve holder plug</b>	Brass
<b>4 = Bell</b>	Polyamide
<b>5 = Regulator knob</b>	Polyamide
<b>6 = Springs</b>	Stainless steel
<b>7 = Diaphragms</b>	NBR
<b>8 = Filters</b>	Stainless steel
<b>9 = Seals</b>	NBR
<b>10 = Piston</b>	Aluminium
<b>11 = Rod</b>	Stainless steel
<b>O-ring</b>	NBR

**Series PR precision regulators - size 1**



\* to complete the code, add the OPERATING PRESSURE (see the CODING EXAMPLE)

PR02 = Regulator with relieving

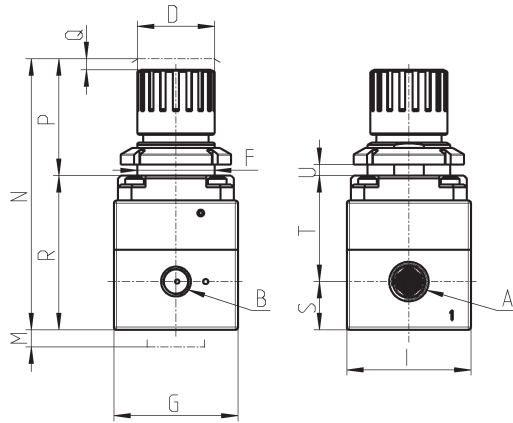
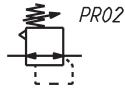

DIMENSIONS																
Mod.	A	B	D	F	G	I	M	N	P	Q	R	S	T	U	Weight (Kg)	
PR104-M*	G1/4	G1/8	28	30	45	45	25	96	40	2	56	17.5	38.5	0-6	0.35	

**Series PR precision regulators - size 2**



\* to complete the code, add the OPERATING PRESSURE (see the CODING EXAMPLE)

PR02 = Regulator with relieving

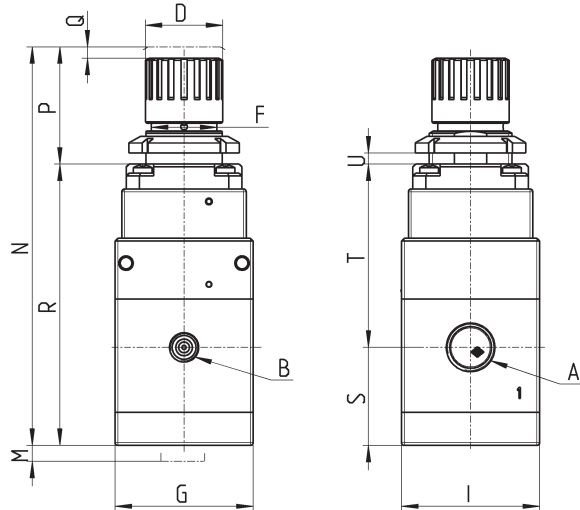

DIMENSIONS																
Mod.	A	B	D	F	G	I	M	N	P	Q	R	S	T	U	Weight (Kg)	
PR204-M*	G1/4	G1/8	28	30	50	50	25	140	40	2	101.8	35.5	66.3	0-6	0.645	
PR238-M*	G3/8	G1/8	28	30	50	50	25	140	40	2	101.8	35.5	66.3	0-6	0.645	

**FLOW DIAGRAMS Mod. PR104-M00**

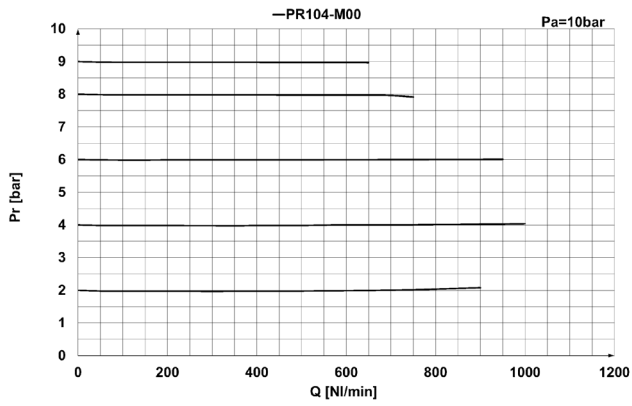

Pr = Regulated pressure (bar)  
 Q = Flow (NL/min)  
 Pa = Inlet pressure (bar)

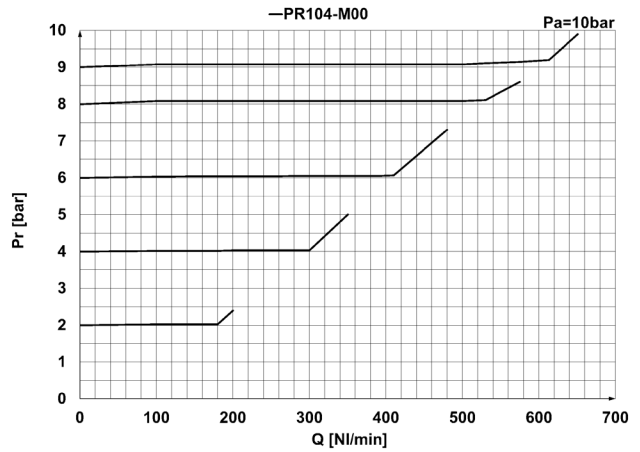

**EXHAUST FLOW**  
 Pr = Regulated pressure (bar)  
 Q = Flow (NL/min)  
 Pa = Inlet pressure (bar)

**FLOW DIAGRAMS Mod. PR104-M07**

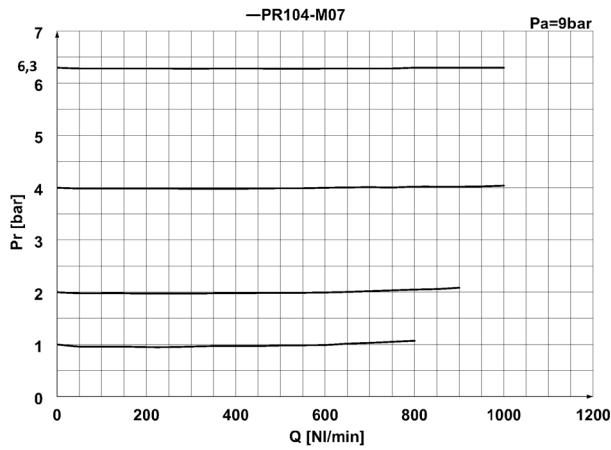

Pr = Regulated pressure (bar)  
 Q = Flow (NL/min)  
 Pa = Inlet pressure (bar)

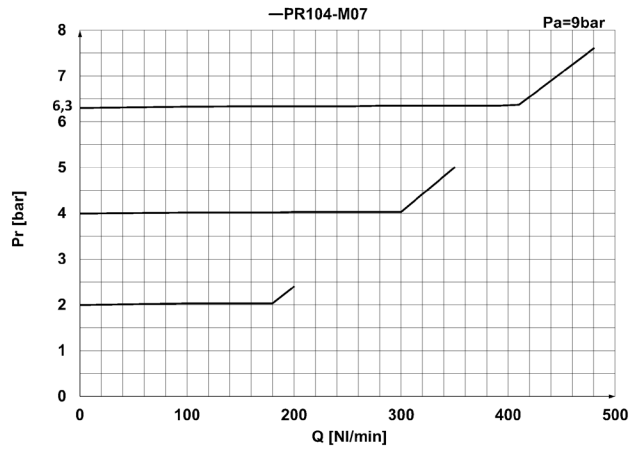

**EXHAUST FLOW**  
 Pr = Regulated pressure (bar)  
 Q = Flow (NL/min)  
 Pa = Inlet pressure (bar)

**FLOW DIAGRAMS Mod. PR104-M04**

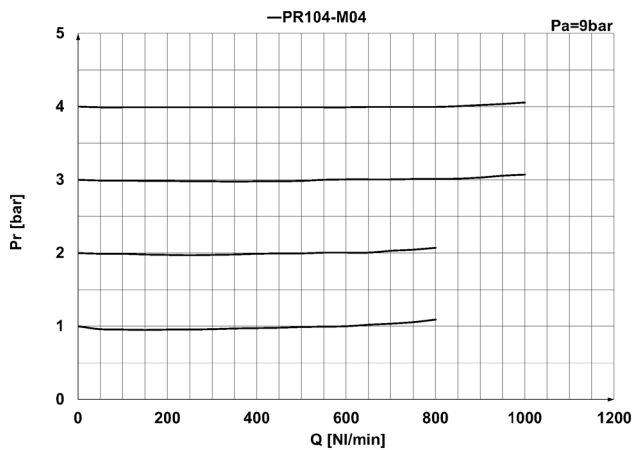

Pr = Regulated pressure (bar)  
 Q = Flow (NL/min)  
 Pa = Inlet pressure (bar)

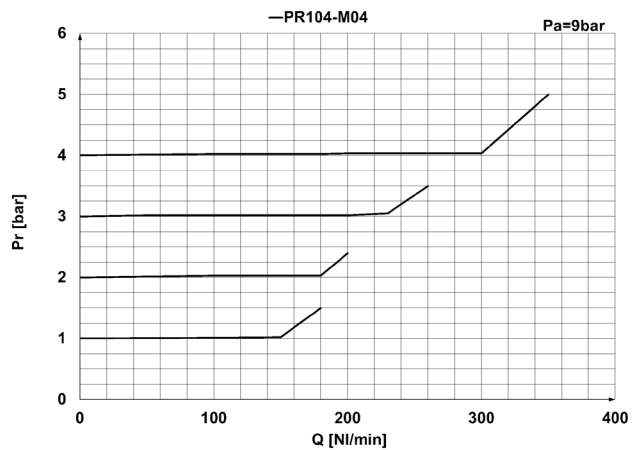

**EXHAUST FLOW**  
 Pr = Regulated pressure (bar)  
 Q = Flow (NL/min)  
 Pa = Inlet pressure (bar)

**FLOW DIAGRAMS Mod. PR104-M02**

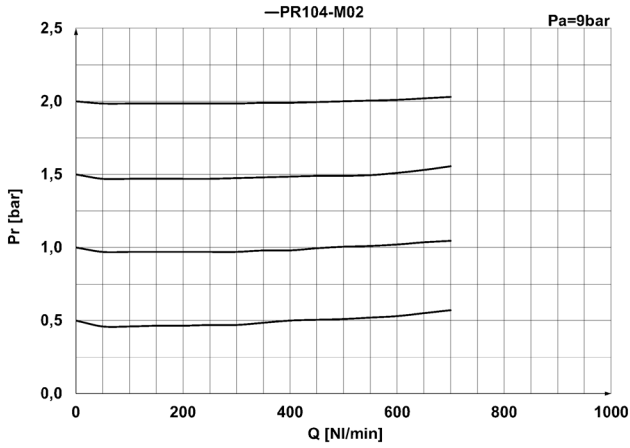

Pr = Regulated pressure (bar)  
Q = Flow (NL/min)  
Pa = Inlet pressure (bar)

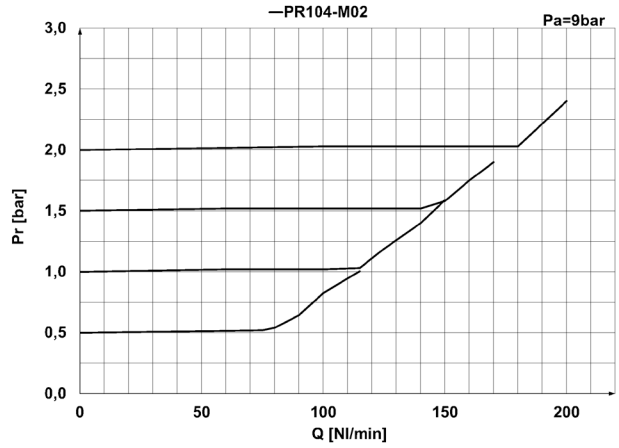

EXHAUST FLOW  
Pr = Regulated pressure (bar)  
Q = Flow (NL/min)  
Pa = Inlet pressure (bar)

**FLOW DIAGRAMS Mod. PR204-M00**

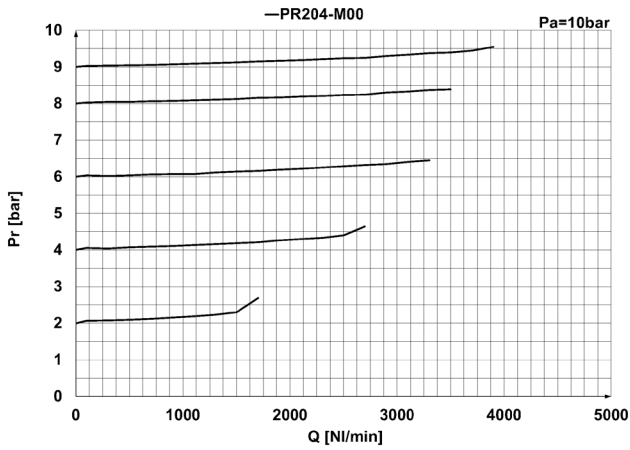

Pr = Regulated pressure (bar)  
Q = Flow (NL/min)  
Pa = Inlet pressure (bar)

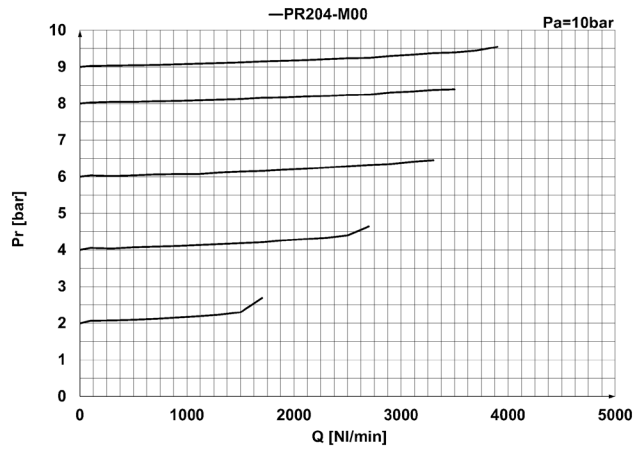

EXHAUST FLOW  
Pr = Regulated pressure (bar)  
Q = Flow (NL/min)  
Pa = Inlet pressure (bar)

**FLOW DIAGRAMS Mod. PR204-M07**

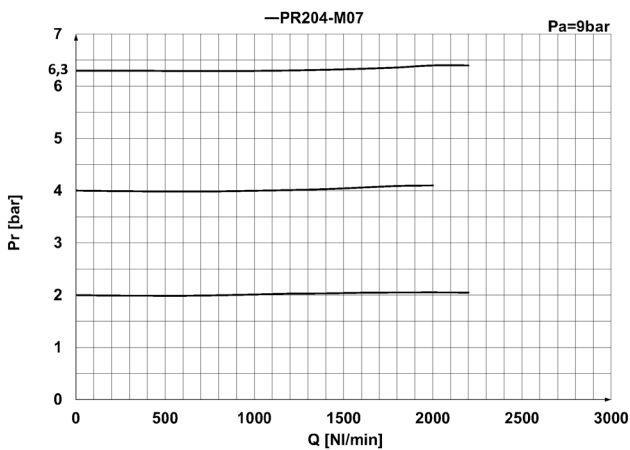

Pr = Regulated pressure (bar)  
Q = Flow (NL/min)  
Pa = Inlet pressure (bar)

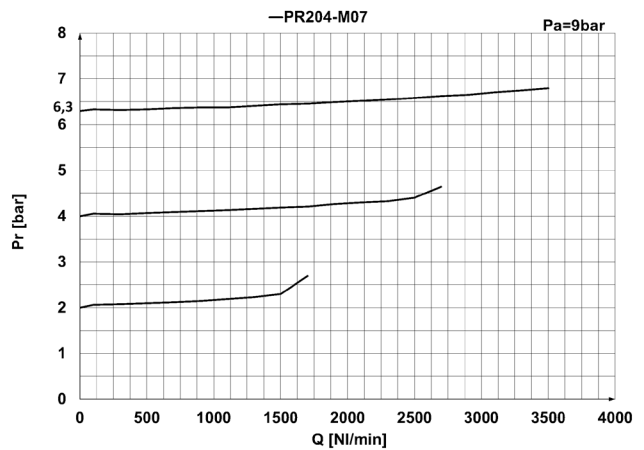

EXHAUST FLOW  
Pr = Regulated pressure (bar)  
Q = Flow (NL/min)  
Pa = Inlet pressure (bar)

**FLOW DIAGRAMS Mod. PR204-M04**

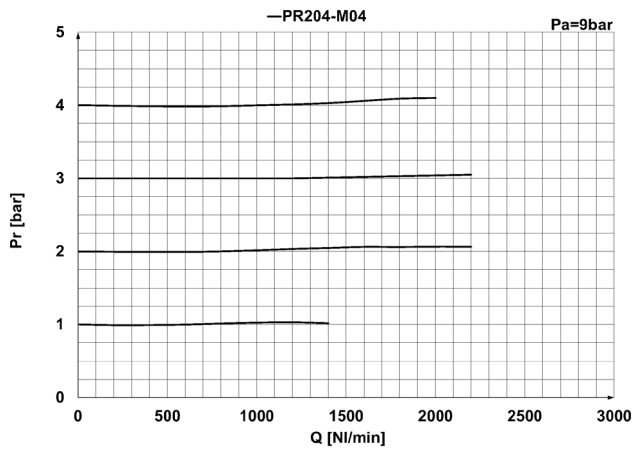

Pr = Regulated pressure (bar)  
 Q = Flow (NL/min)  
 Pa = Inlet pressure (bar)

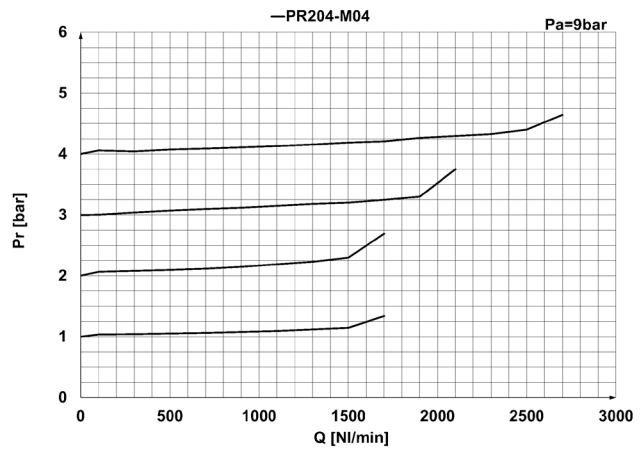

**EXHAUST FLOW**  
 Pr = Regulated pressure (bar)  
 Q = Flow (NL/min)  
 Pa = Inlet pressure (bar)

**FLOW DIAGRAMS Mod. PR204-M02**

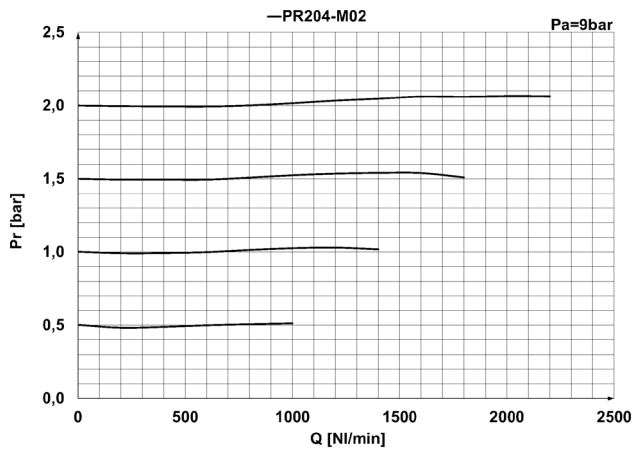

Pr = Regulated pressure (bar)  
 Q = Flow (NL/min)  
 Pa = Inlet pressure (bar)

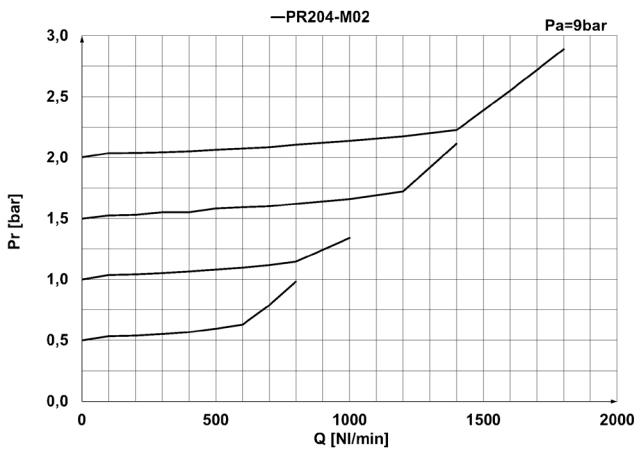

**EXHAUST FLOW**  
 Pr = Regulated pressure (bar)  
 Q = Flow (NL/min)  
 Pa = Inlet pressure (bar)

**FLOW DIAGRAMS Mod. PR238-M00**

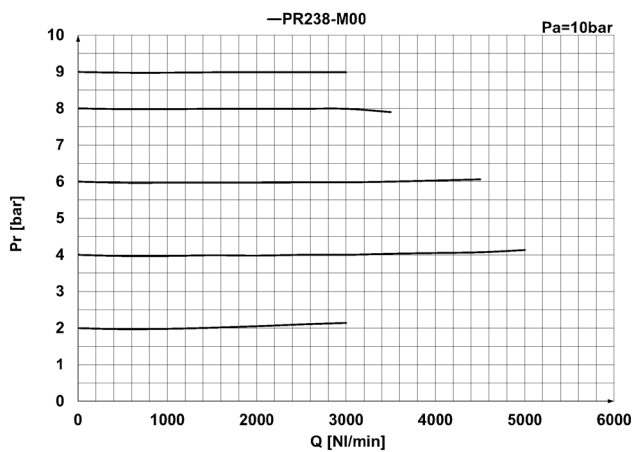

Pr = Regulated pressure (bar)  
 Q = Flow (NL/min)  
 Pa = Inlet pressure (bar)

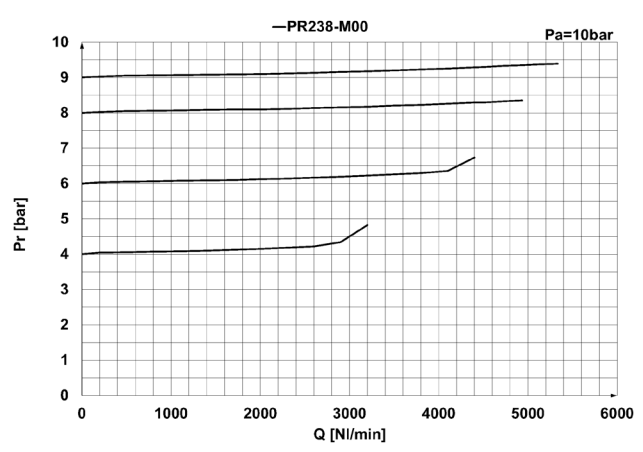

**EXHAUST FLOW**  
 Pr = Regulated pressure (bar)  
 Q = Flow (NL/min)  
 Pa = Inlet pressure (bar)

**FLOW DIAGRAMS Mod. PR238-M07**

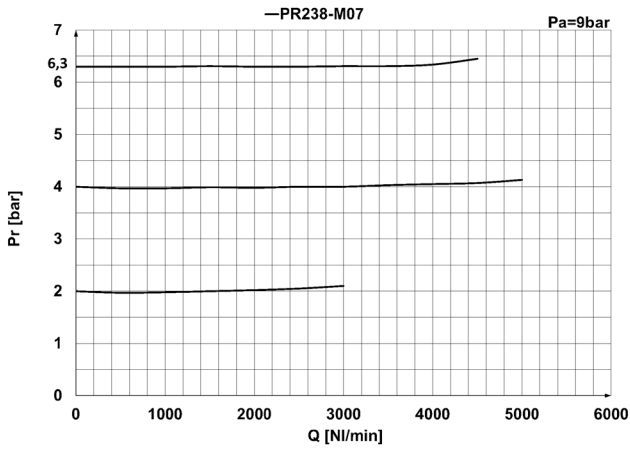

Pr = Regulated pressure (bar)  
Q = Flow (NL/min)  
Pa = Inlet pressure (bar)

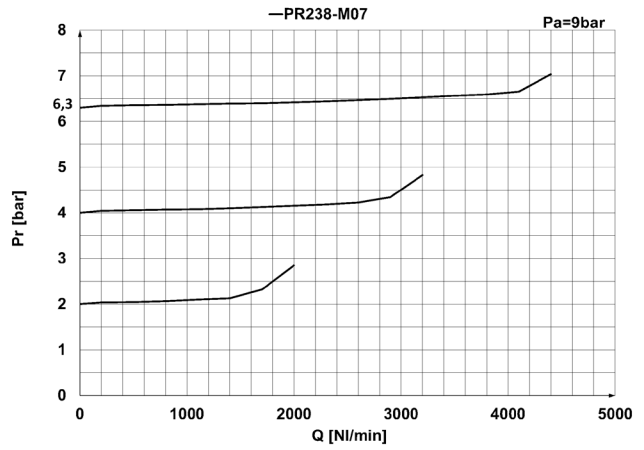

EXHAUST FLOW  
Pr = Regulated pressure (bar)  
Q = Flow (NL/min)  
Pa = Inlet pressure (bar)

**FLOW DIAGRAMS Mod. PR238-M04**

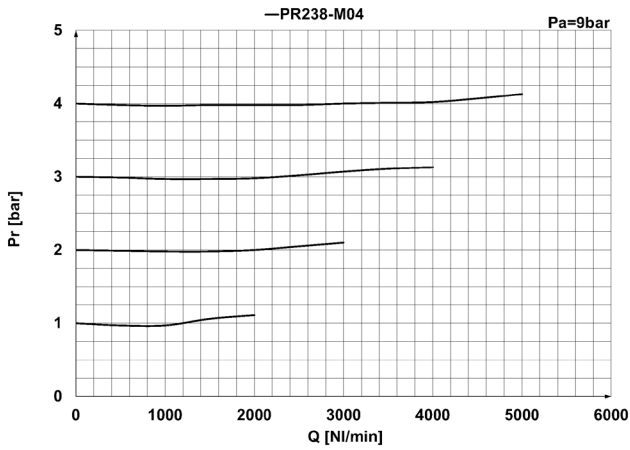

Pr = Regulated pressure (bar)  
Q = Flow (NL/min)  
Pa = Inlet pressure (bar)

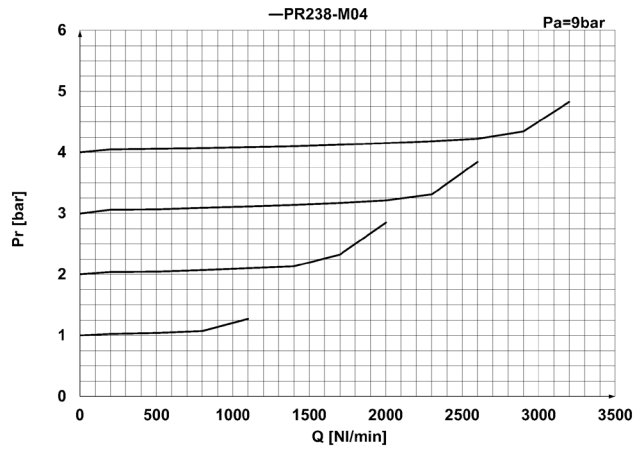

EXHAUST FLOW  
Pr = Regulated pressure (bar)  
Q = Flow (NL/min)  
Pa = Inlet pressure (bar)

**FLOW DIAGRAMS Mod. PR238-M02**

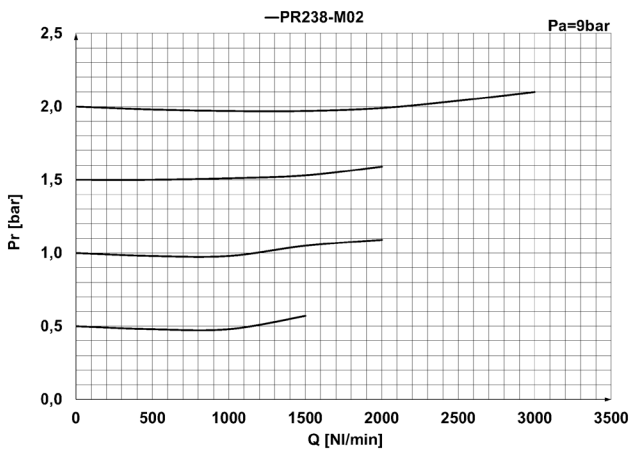

Pr = Regulated pressure (bar)  
Q = Flow (NL/min)  
Pa = Inlet pressure (bar)

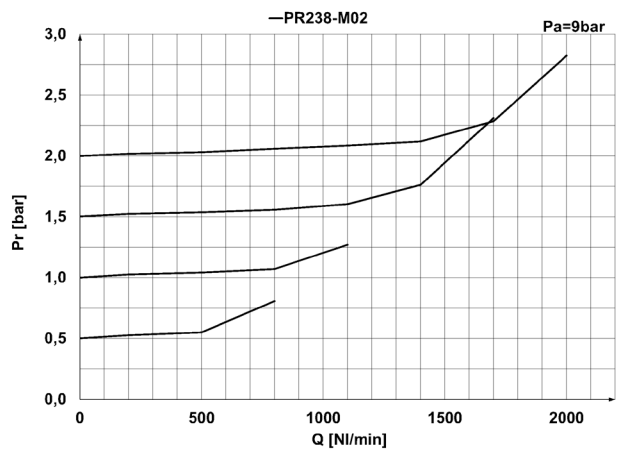

EXHAUST FLOW  
Pr = Regulated pressure (bar)  
Q = Flow (NL/min)  
Pa = Inlet pressure (bar)