

detaliu arbore

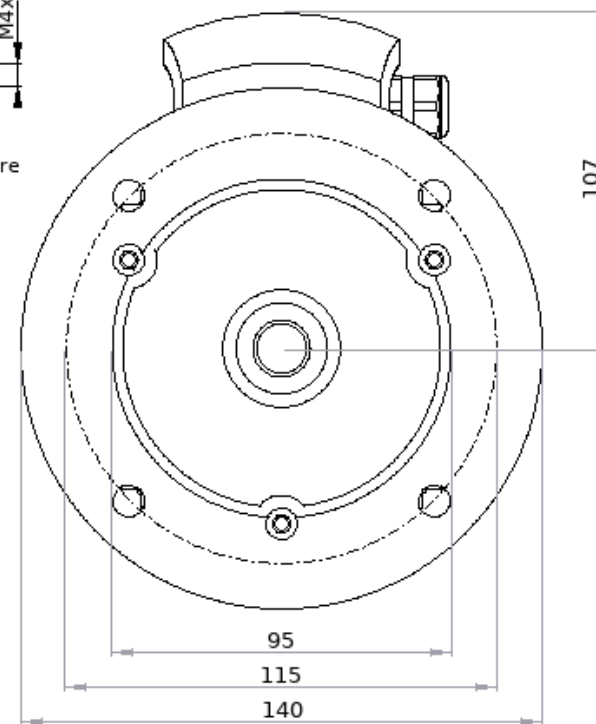



Motive s.r.l.
Via Le Ghiselle, 20
25014 Castenedolo (BS), Italy
Tel: +39 030 2677087
Fax: +39 030 2677125
motive@motive.com
www.motive.it

Fisa tehnica

DESCRIEREA PRODUSULUI

Producător	Motive s.r.l.
Tipul de motor	DELPHI 63C-2
Cod motor	-
Versiune	standard
# poli:	2
Configurare	B5

Altitudinea maxima	1000 m a.s.l.
Temperatură Creștere ΔT	51 °C
Caracteristici	Aluminum motor
Infasurare tropicalizată (standard)	
Greutate	5.7 Kg
Clasa de eficiență	IE2

Date de sarcină	100%	75%	50%
Eficiență $\eta\%$ la 50Hz	76.40	76.30	72.80
Factor de putere $\cos\phi$	0.76	0.65	0.51

Nivelul de presiune al sunetului (Lwa)	61 [dB]
Rotor Inertia	0.00075 Kg ^m
Rulment DE	6201 ZZ
Rulment NDE	6201 ZZ

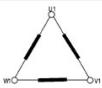
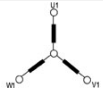
Hz	50	
Conexiune		
Volt	230V	400V
Putere kW	0.37	
Hp	0.5	
Viteză rpm	2791	
cuplu nominal Cn	1.27	
Curent nominal In	1.62	0.93
Curent de pornire Is	7.18	4.13
Cuplu de pornire Cs	3.6	
Cuplu maxim Cmax	3.67	

Protecție	IP 55
Is/In	4.50
Cs/Cn	2.80
Cmax/Cn	2.90



curva coppia/assorbimento

16/03/2009

torque and current curve

Tipo motore : 63C-2

V Nom. [V] : 400

Frequenza [Hz] : 50

P Nom.[KW] : 0,37

Giri [min⁻¹] : 2796

File Prova : C:\Elektro\Prove\Trifase\63\ 63C-2 B3 0805F0018 16MAR09.TXT

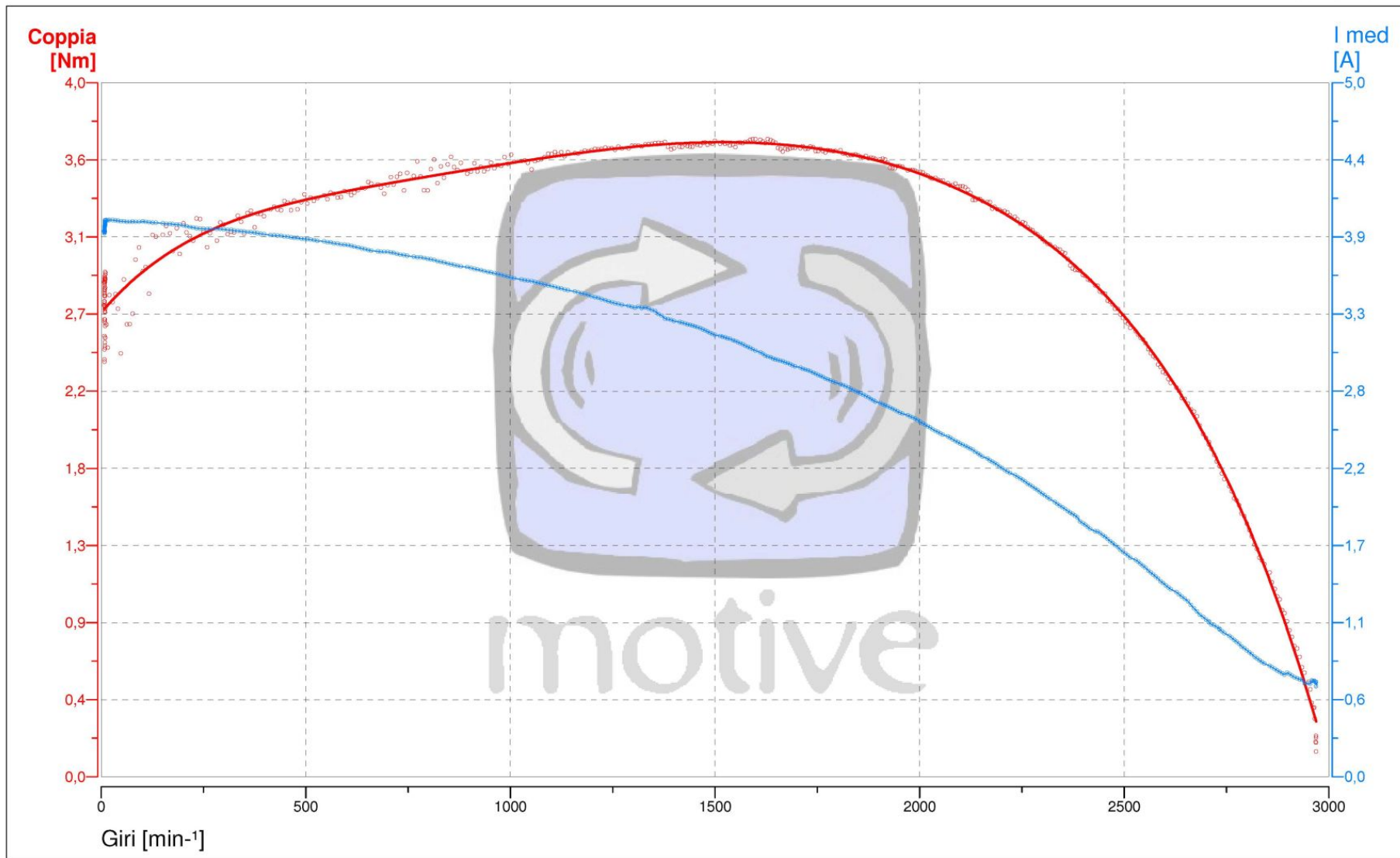

Note : Fabio



RENDIMENTO

16/03/2009

EFFICIENCY

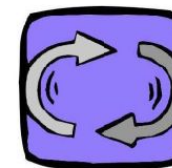

motive

Tipo motore : 63C-2

V Nom. [V] : 400

Frequenza [Hz] : 50

P Nom.[KW] : 0,37

Giri [min-1] : 2796

File Prova : C:\Elektro\Prove\Trifase\63\ 63C-2 B3 (Fabio) 0805F0018 16MAR09.TXT

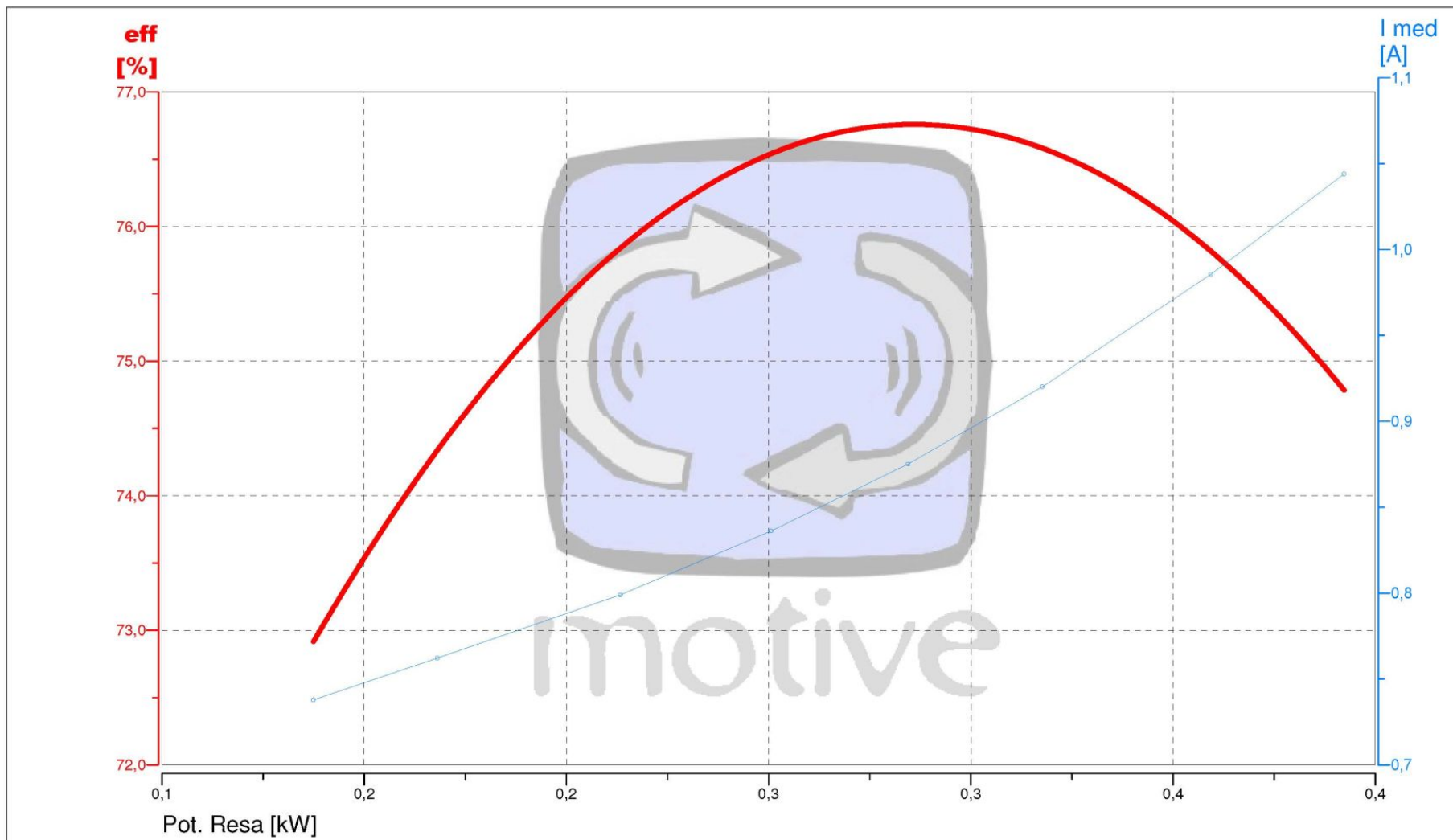

Note : Fabio



riscaldamento

16/03/2009

heating

Tipo motore : 63C-2

V Nom. [V] : 400

Frequenza [Hz] : 50

P Nom.[KW] : 0,37

Giri [min⁻¹] : 2796

File Prova : C:\Elektro\Prove\Trifase\63\ 63C-2 B3 (Fabio) 0805F0018 16MAR09.TXT

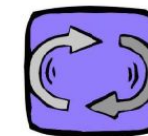

motive

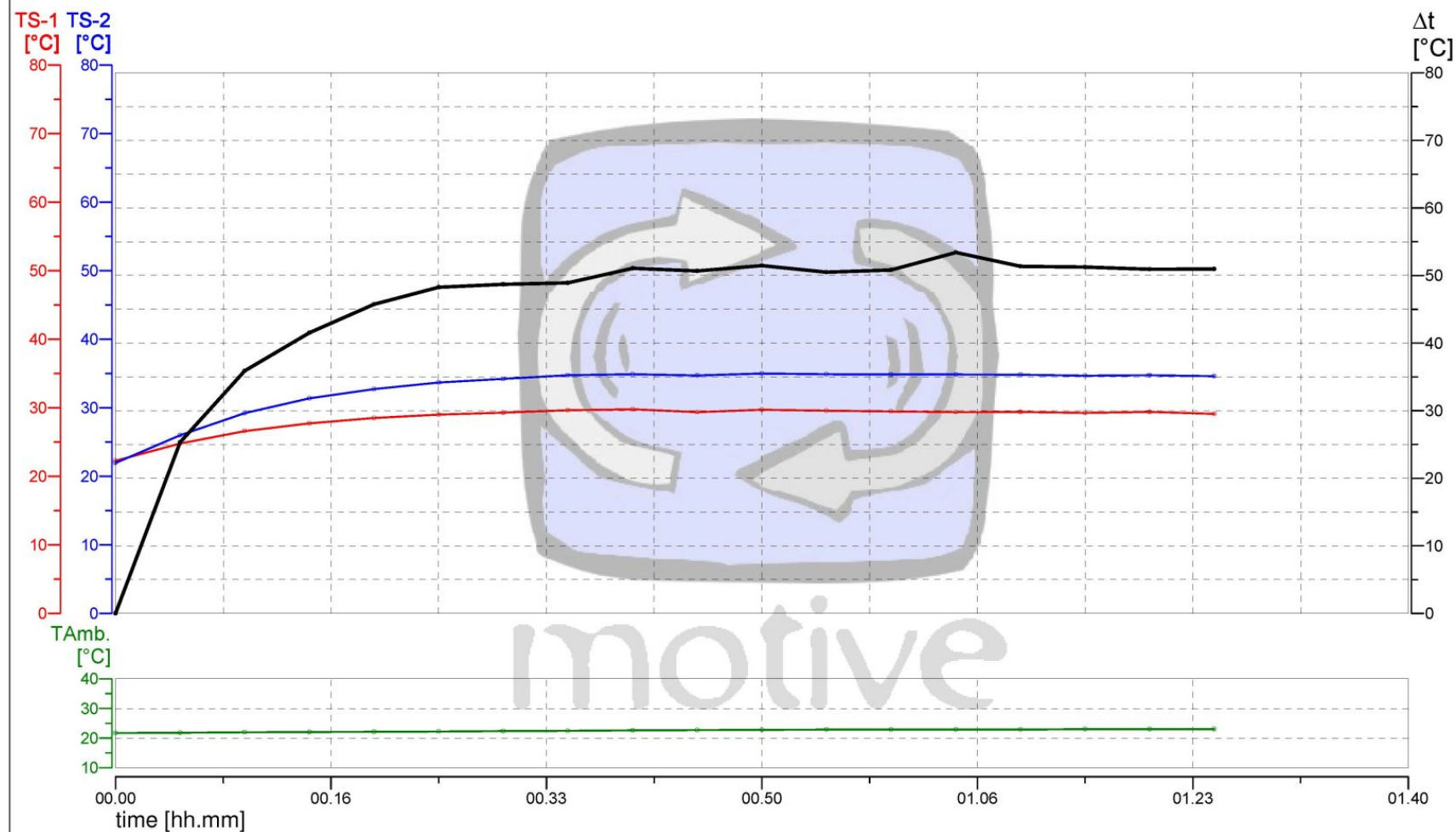

Note : Fabio





motive

Motive s.r.l.
Via Le Ghiselle, 20
25014 Castenedolo (BS)
Tel.: +39 030 2677 087
Fax: +39 030 2677 125
motive@e-motive.it



Conformity Declaration

Motive s.r.l. whose Head Office is situated in Castenedolo (BS) - Italy

declares, under its own exclusive responsibility,

that its whole range of

asynchronous electric motors of the series "Delphi" and "DELFIRE"

is conform to the following international norms (last issue):

- EN60034-1** Rotating Electrical Machines - Part 1: Rating and performance
- EN60034-6** Rotating Electrical Machines - Part 6: Methods of cooling (IC code)
- EN60034-7** Rotating Electrical Machines - Part 7: Classification of Types of Construction, Mounting Arrangements and Terminal Box Position (IM Code)
- EN60034-8** Rotating electrical machines - Part 8: Terminal markings and direction of rotation
- EN60034-25** Rotating electrical machines - Part 25: Guidance for the design and performance of a.c. motors specifically designed for converter supply
- EN60034-2-1** Rotating electrical machines. Standard methods for determining losses and efficiency from tests
- EN60034-30-1** Rotating electrical machines - Part 30: Efficiency classes of single-speed, three-phase, cage-induction motors
- EN50347** General purpose three-phase induction motors having standard dimensions and outputs. Frame numbers 56 to 315 and flange numbers 65 to 740
- EN61000-6-4** Electromagnetic compatibility (EMC) - Part 6: Generic standards - Section 4: Emission standard for industrial environments
- IEC 72-1** Dimensions and output series for rotating electrical machines Part 1: Frame numbers 56 to 400 and flange numbers 55 to 1080

following the provisions of the Directives

Low Voltage (LVD) 14/35/EEC,
EMC Electromagnetic Compatibility (EMC) 14/30/EEC
Eco-design Directive for Energy-related Products (ErP) 09/125/EEC

1 January 2016

The Legal Representative: *Giorgia Bosio*

N. REA 422301
Cod. Fisc. e P. IVA 03580280174



Milan, September 30, 2008

Attention to Company

Motive S.r.l.
Via Artigianale, 110/112
25010 Mostre (BS) - ITALY

Dear Mr Giorgio Bosio,

Herewith I confirm that Motive's laboratory, evaluated according to the requirements of standard IEC/ISO 17025, is found in compliance with main requirements of the above mentioned standard. The following motors were tested according to standard IEC 60034-2 with supervision of IMQ qualified personnel.

Model designation rated power (kW)

90L-4 Eff1	1,5
100LB-4 Eff1	3
112M-4 Eff1	4
132M-4 Eff1	7,5
90L-2 Eff1	2,2
112M-2 Eff1	4
132SB-2 Eff1	7,5
112M-6 Eff1	2,2
132S-6 Eff1	3
100LA-8 Eff1	0,75
132M-8 Eff1	3

With Regards



Igor Balassi

Household Appliances Laboratory Manager
Tel. (+39) 025073484
igor.balassi@imq.it

IMQ S.p.A.
Via Quintilano 43
20138 Milano
Tel. (+39) 0250731
www.imq.it - info@imq.it





TYPE APPROVAL CERTIFICATE

N. ELE391318CS001

This is to certify that the product below is found to be in compliance with the applicable requirements of the RINA Type Approval system.

Description	Asynchronous three-phases electric motors
Type	DELPHI Series
Applicant	Motive S.r.l. Via Le Ghiselle, 20 25014 Castenedolo (BS) Italy
Manufacturing Place	Motive S.r.l. Via Le Ghiselle, 20 25014 Castenedolo (BS) Italy
Testing Standards	RINA Rules for the Classification of Ships – Part C, Ch.2, Sec. 4

Issued in Genova on January 21, 2019

This certificate is valid until January 21, 2024

Valerio Bonanni

RINA Services S.p.A.

Valerio Bonanni



RINA Services S.p.A.
Via Corsica, 12 – 16128 Genova

Page 1/2

KINGDOM OF SAUDI ARABIA

Product Conformity Programme

Statement for Registration

PCP Ref.no: KSA R-205239

Issued to:

Motive Srl
Via Artigianale 110/112
25010 Montirone (BS)
Italy

Product:

II-06 MOTORS Incl. GEARED MOTORS/DRIVES

Model/Type:

See appendix (1 page/s)

Applicable standards/references:

IEC 60034, IEC 72

Issued by:

Regional Licensing Centre
Europe, Middle East and Africa
Intertek Semko AB
06 November 2009



Pia Östgaard
Pia Östgaard
Manager

This Statement for Registration is for the exclusive use of Intertek's Client and is provided pursuant to the agreement between Intertek and its Client. Intertek's responsibility and liability are limited to the terms and conditions of the agreement. Intertek assumes no liability to any part, other than to the Client in accordance with the agreement, for any loss, expense or damage occasioned by the use of this Statement for Registration. Only the Client is authorized to permit copying or distribution of this Statement for Registration and then only in its entirety. Any use of the Intertek name for the sale or advertisement of the tested material, product or service must first be approved in writing by Intertek.

Handwritten mark



ZERTIFIKAT ♦ CERTIFICATE ♦ 認證證書 ♦ СЕРТИФИКАТ ♦ CERTIFICADO ♦ CERTIFICAT



CERTIFICATO

Nr. 50 100 1185 - Rev.010

Si attesta che / This is to certify that

IL SISTEMA QUALITÀ DI
THE QUALITY SYSTEM OF



motive
MOTIVE S.r.l.

SEDE LEGALE E OPERATIVA:
REGISTERED OFFICE AND OPERATIONAL SITE:

VIA LE GHISSELLE 20
IT - 25014 CASTENEDOLO (BS)

È CONFORME AI REQUISITI DELLA NORMA
HAS BEEN FOUND TO COMPLY WITH THE REQUIREMENTS OF

UNI EN ISO 9001:2015

QUESTO CERTIFICATO È VALIDO PER IL SEGUENTE CAMPO DI APPLICAZIONE
THIS CERTIFICATE IS VALID FOR THE FOLLOWING SCOPE

**Progettazione e fabbricazione di motori elettrici, riduttori
meccanici e inverter (IAF 18, 19)**

**Design and manufacture of electrical motors, mechanical gearboxes
and variable speed drives (IAF 18, 19)**



SGQ N° 049A

Membro degli Accordi di Mutuo Riconoscimento
EA, IAF e ILAC
Signatory of EA, IAF and ILAC Mutual
Recognition Agreements

Per l'Organismo di Certificazione
For the Certification Body
TÜV Italia S.r.l.

Validità / Validity

Dal / From: 2019-03-19

Al / To: 2022-03-02

Data emissione / Issuing Date

Andrea Coscia
Direttore Divisione Business Assurance

2019-03-19

PRIMA CERTIFICAZIONE / FIRST CERTIFICATION: 2001-07-20
DATA DI SCADENZA DELL'ULTIMO CICLO DI CERTIFICAZIONE: 2019-03-02
EXPIRATION DATE OF THE LAST CERTIFICATION CYCLE: 2019-03-02

"LA VALIDITÀ DEL PRESENTE CERTIFICATO È SUBORDINATA A SORVEGLIANZA PERIODICA A 12 MESI E AL RIESAME COMPLETO DEL SISTEMA DI GESTIONE AZIENDALE CON PERIODICITÀ TRIENNALE"
"THE VALIDITY OF THE PRESENT CERTIFICATE DEPENDS ON THE ANNUAL SURVEILLANCE EVERY 12 MONTHS AND ON THE COMPLETE REVIEW OF COMPANY'S MANAGEMENT SYSTEM AFTER THREE-YEARS"

TÜV Italia S.r.l. • Gruppo TÜV SÜD • Via Carducci 125, Pal. 23 • 20099 Sesto San Giovanni (MI) • Italia • www.tuv.it TÜV®

T01-1481

