

Vacuum switch VS4016, G1/8" male, 15.0 -inHg, 01.10.249



- Pre-set vacuum switch with digital output.
- Very low weight and small format, push-in or thread connections.
- PNP NO/NC or NPN NO/NC output functions.

General

Material	CuZn (Au), PA, SS, Thermoplastic Polyurethane (TPE-U)
Temperature	-13 – 185 °F
Weight	0.18 oz

Performance

Feed pressure, max.	29.0 psi (@ vacuum connection)
---------------------	--------------------------------

Electrical data

Current, inductive, max.	0.1 A
Current, resistive, max.	0.4 A
Display	LED indicator
Safety classification	IP40
Voltage	24 (12-30) VDC
Voltage drop, max	0.055 VDC

Pneumatic data

Valve function	NC, NO
----------------	--------

Dimension

Height	0.85 in
Length	0.63 in
Width	0.63 in

Signal function

Hysteresis	5-7 kPa
Signal range	13.88 – 16.24 -inHg

Dimensional drawings

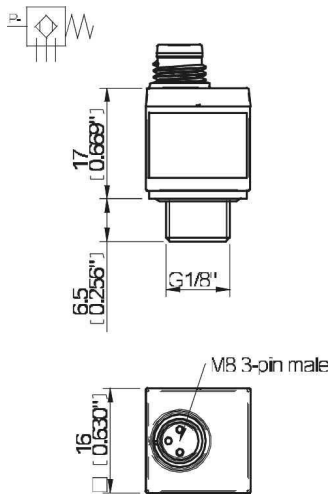

Accessories

	Part no.
Cable M8 3-pin female L=2m	01.08.141