

detaliu arbore

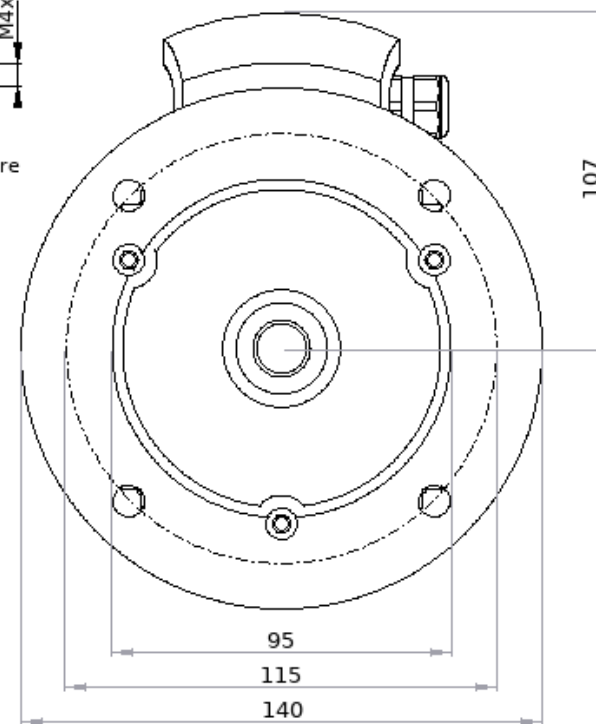



Motive s.r.l.  
Via Le Ghiselle, 20  
25014 Castenedolo (BS), Italy  
Tel: +39 030 2677087  
Fax: +39 030 2677125  
motive@motive.com  
www.motive.it

# Fisa tehnica

## DESCRIEREA PRODUSULUI

Producător	Motive s.r.l.
Tipul de motor	DELPHI 63A-4
Cod motor	63A-4B5
Versiune	standard
# poli:	4
Configurare	B5

Altitudinea maxima	1000 m a.s.l.
Temperatură Creștere ΔT	30 °C
Caracteristici	Aluminum motor
Infasurare tropicalizată (standard)	
Greutate	4.5 Kg
Clasa de eficiență	IE2

Date de sarcină	100%	75%	50%
Eficiență η% la 50Hz	64.70	63.90	62
Factor de putere cosφ	0.72	0.62	0.59

Nivelul de presiune al sunetului (Lwa)	52 [dB]
Rotor Inertia	0.00050 Kgm <sup>2</sup>
Rulment DE	6201 ZZ
Rulment NDE	6201 ZZ

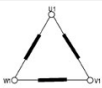
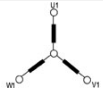
Hz	50	
Conexiune		
Volt	230V	400V
Putere kW	0.13	
Putere Hp	0.18	
Viteză rpm	1355	
cuplu nominal Cn	0.92	
Curent nominal In	0.70	0.40
Curent de pornire Is	2.23	1.28
Cuplu de pornire Cs	2.1	
Cuplu maxim Cmax	2.1	

Protecție	IP 55
Is/In	3.20
Cs/Cn	2.30
Cmax/Cn	2.30



# curva coppia/assorbimento

29/12/2006

torque and current curve

Tipo motore : 63A-4

V Nom. [V] : 400

Frequenza [Hz] : 50

P Nom.[KW] : 0,13

Giri [min<sup>-1</sup>] : 1310

File Prova : C:\Elektro\Prove\Trifase\63\ 63A-4 B3 06050441.TXT

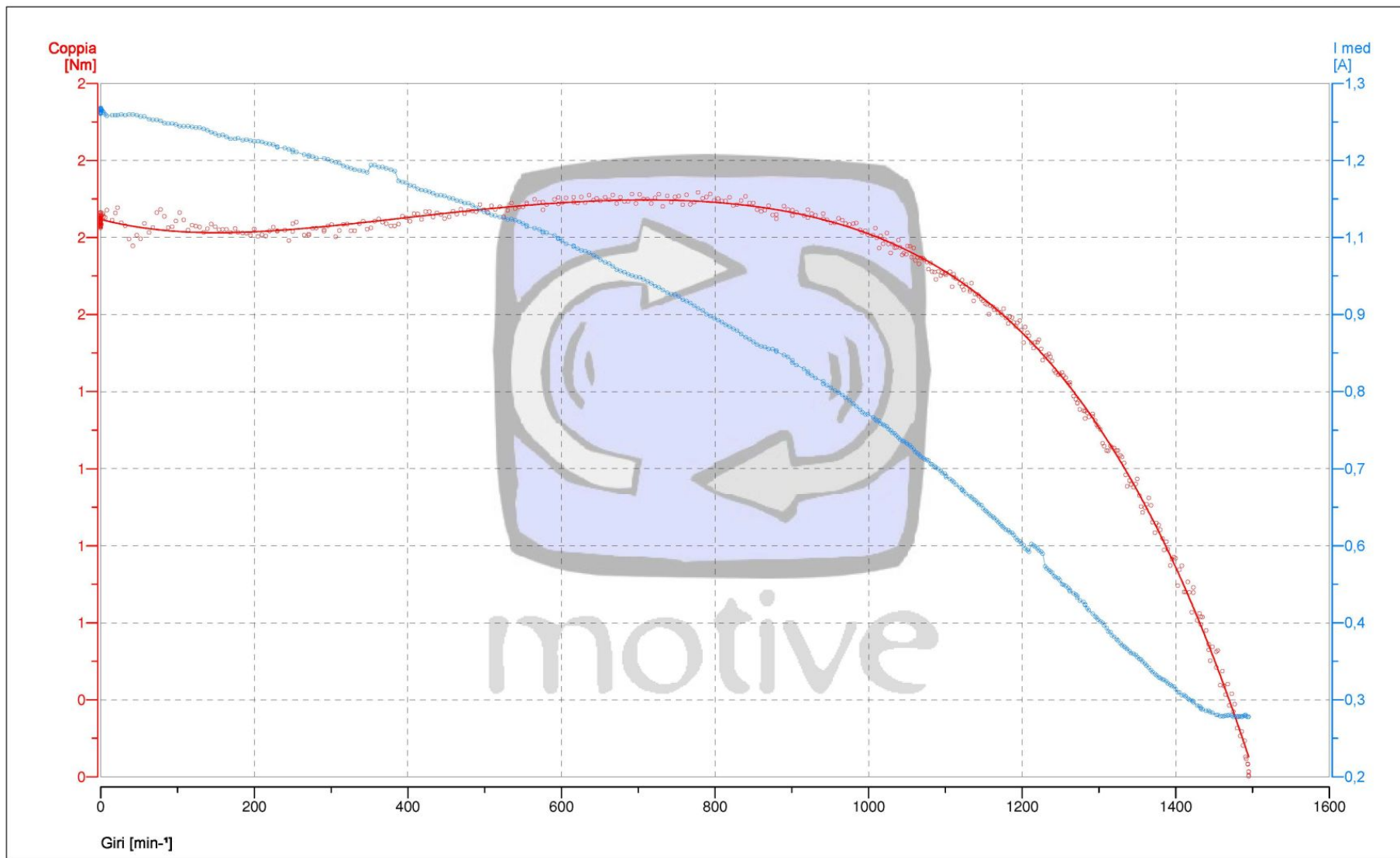

Note :



# RENDIMENTO

## EFFICIENCY

29/12/2006

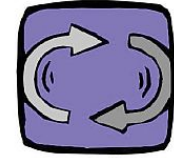

motive

Matricola : 06050441

V Nom. [V] : 50

Pot. assorbita [KW] :

P Nom. [KW] :

Servizio : S1

File Prova : C:\Elektro\Prove\Trifase\63\ 63A-4 B3 06050441.TXT

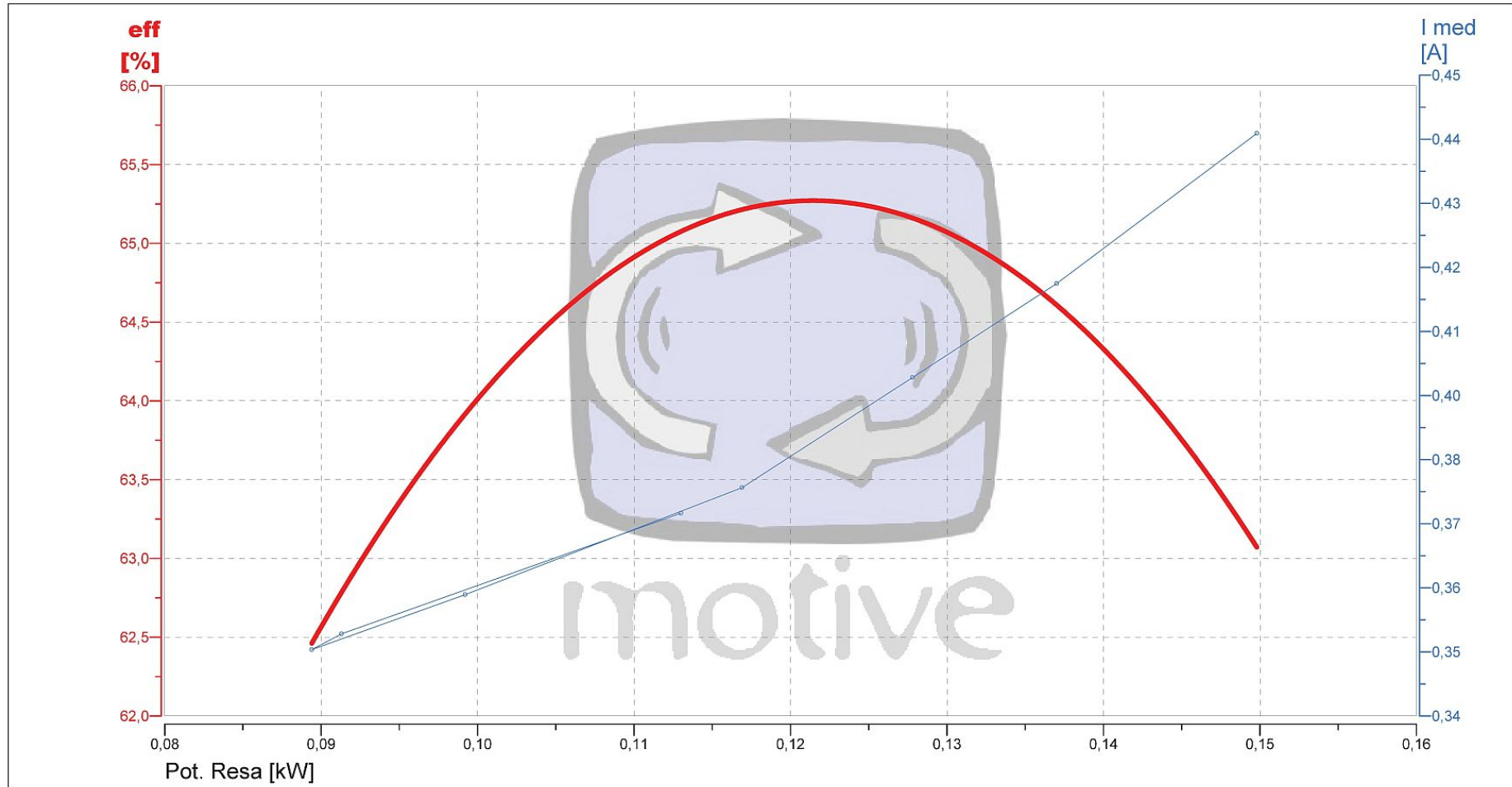

Note :



# riscaldamento

29/12/2006

heating

Tipo motore : 63A-4

V Nom. [V] : 400

Frequenza [Hz] : 50

P Nom.[KW] : 0,13

Giri [min<sup>-1</sup>] : 1310

File Prova : C:\Elektro\Prove\Trifase\63\ 63A-4 B3 06050441.TXT

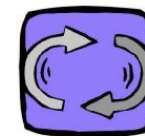

motive

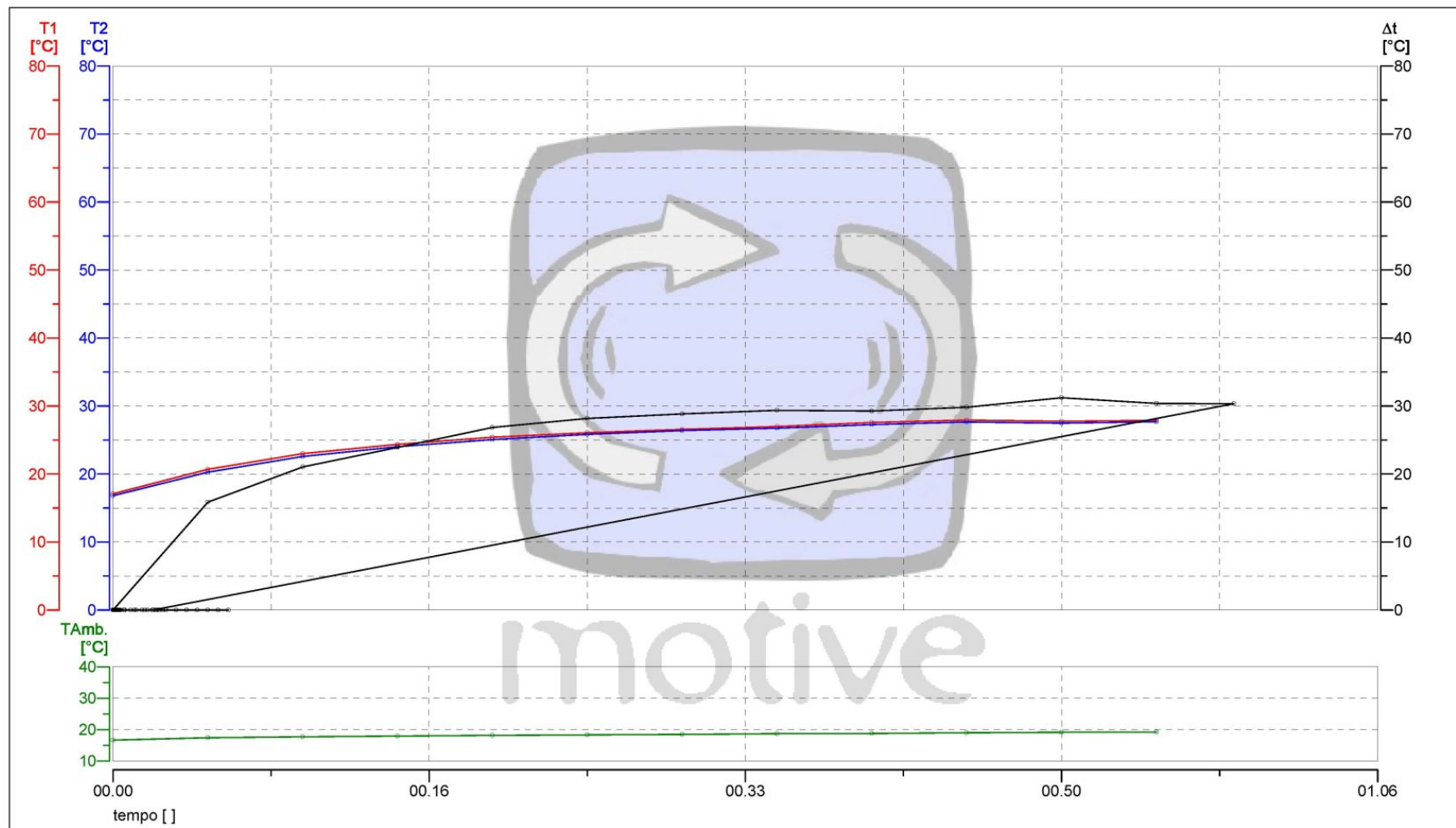

Note :





motive

Motive s.r.l.  
Via Le Ghiselle, 20  
25014 Castenedolo (BS)  
Tel.: +39 030 2677 087  
Fax: +39 030 2677 125  
motive@e-motive.it



## Conformity Declaration

Motive s.r.l. whose Head Office is situated in Castenedolo (BS) - Italy

declares, under its own exclusive responsibility,

that its whole range of

**asynchronous electric motors of the series "Delphi" and "DELFIRE"**

is conform to the following international norms (last issue):

- EN60034-1** Rotating Electrical Machines - Part 1: Rating and performance
- EN60034-6** Rotating Electrical Machines - Part 6: Methods of cooling (IC code)
- EN60034-7** Rotating Electrical Machines - Part 7: Classification of Types of Construction, Mounting Arrangements and Terminal Box Position (IM Code)
- EN60034-8** Rotating electrical machines - Part 8: Terminal markings and direction of rotation
- EN60034-25** Rotating electrical machines - Part 25: Guidance for the design and performance of a.c. motors specifically designed for converter supply
- EN60034-2-1** Rotating electrical machines. Standard methods for determining losses and efficiency from tests
- EN60034-30-1** Rotating electrical machines - Part 30: Efficiency classes of single-speed, three-phase, cage-induction motors
- EN50347** General purpose three-phase induction motors having standard dimensions and outputs. Frame numbers 56 to 315 and flange numbers 65 to 740
- EN61000-6-4** Electromagnetic compatibility (EMC) - Part 6: Generic standards - Section 4: Emission standard for industrial environments
- IEC 72-1** Dimensions and output series for rotating electrical machines Part 1: Frame numbers 56 to 400 and flange numbers 55 to 1080

following the provisions of the Directives

**Low Voltage (LVD) 14/35/EEC,**

**EMC Electromagnetic Compatibility (EMC) 14/30/EEC**

**Eco-design Directive for Energy-related Products (ErP) 09/125/EEC**

1 January 2016

The Legal Representative: *Giorgia Bosio*

N. REA 422301  
Cod. Fisc. e P. IVA 03580280174



Milan, September 30, 2008

Attention to Company

Motive S.r.l.  
Via Artigianale, 110/112  
25010 Mostrone (BS) - ITALY

Dear Mr Giorgio Bosio,

Herewith I confirm that Motive's laboratory, evaluated according to the requirements of standard IEC/ISO 17025, is found in compliance with main requirements of the above mentioned standard. The following motors were tested according to standard IEC 60034-2 with supervision of IMQ qualified personnel.

Model designation    rated power (kW)

90L-4 Eff1	1,5
100LB-4 Eff1	3
112M-4 Eff1	4
132M-4 Eff1	7,5
90L-2 Eff1	2,2
112M-2 Eff1	4
132SB-2 Eff1	7,5
112M-6 Eff1	2,2
132S-6 Eff1	3
100LA-8 Eff1	0,75
132M-8 Eff1	3

With Regards



Igor Balassi

Household Appliances Laboratory Manager  
Tel. (+39) 025073484  
igor.balassi@imq.it

IMQ S.p.A.  
Via Quintilano 43  
20138 Milano  
Tel. (+39) 0250731  
www.imq.it - info@imq.it





# TYPE APPROVAL CERTIFICATE

N. ELE391318CS001

This is to certify that the product below is found to be in compliance with the applicable requirements of the RINA Type Approval system.

<b>Description</b>	Asynchronous three-phases electric motors
<b>Type</b>	DELPHI Series
<b>Applicant</b>	Motive S.r.l. Via Le Ghiselle, 20 25014 Castenedolo (BS) Italy
<b>Manufacturing Place</b>	Motive S.r.l. Via Le Ghiselle, 20 25014 Castenedolo (BS) Italy
<b>Testing Standards</b>	RINA Rules for the Classification of Ships – Part C, Ch.2, Sec. 4

Issued in Genova on January 21, 2019

This certificate is valid until January 21, 2024

*Valerio Bonanni*

RINA Services S.p.A.

*Valerio Bonanni*



RINA Services S.p.A.  
Via Corsica, 12 – 16128 Genova

Page 1/2

## KINGDOM OF SAUDI ARABIA

Product Conformity Programme

Statement for Registration

PCP Ref.no: KSA R-205239

Issued to:

Motive Srl  
Via Artigianale 110/112  
25010 Montirone (BS)  
Italy

Product:

II-06 MOTORS Incl. GEARED MOTORS/DRIVES

Model/Type:

See appendix (1 page/s)

Applicable standards/references:

IEC 60034, IEC 72

Issued by:

Regional Licensing Centre  
Europe, Middle East and Africa  
Intertek Semko AB  
06 November 2009



*Pia Östgaard*  
Pia Östgaard  
Manager

This Statement for Registration is for the exclusive use of Intertek's Client and is provided pursuant to the agreement between Intertek and its Client. Intertek's responsibility and liability are limited to the terms and conditions of the agreement. Intertek assumes no liability to any part, other than to the Client in accordance with the agreement, for any loss, expense or damage occasioned by the use of this Statement for Registration. Only the Client is authorized to permit copying or distribution of this Statement for Registration and then only in its entirety. Any use of the Intertek name for the sale or advertisement of the tested material, product or service must first be approved in writing by Intertek.

*Handwritten mark*





ZERTIFIKAT ♦ CERTIFICATE ♦ 認證證書 ♦ СЕРТИФИКАТ ♦ CERTIFICADO ♦ CERTIFICAT



# CERTIFICATO

Nr. 50 100 1185 - Rev.010

Si attesta che / This is to certify that

IL SISTEMA QUALITÀ DI  
THE QUALITY SYSTEM OF



**motive**  
**MOTIVE S.r.l.**

SEDE LEGALE E OPERATIVA:  
REGISTERED OFFICE AND OPERATIONAL SITE:

**VIA LE GHISSELLE 20**  
**IT - 25014 CASTENEDOLO (BS)**

È CONFORME AI REQUISITI DELLA NORMA  
HAS BEEN FOUND TO COMPLY WITH THE REQUIREMENTS OF

**UNI EN ISO 9001:2015**

QUESTO CERTIFICATO È VALIDO PER IL SEGUENTE CAMPO DI APPLICAZIONE  
THIS CERTIFICATE IS VALID FOR THE FOLLOWING SCOPE

**Progettazione e fabbricazione di motori elettrici, riduttori  
meccanici e inverter (IAF 18, 19)**

**Design and manufacture of electrical motors, mechanical gearboxes  
and variable speed drives (IAF 18, 19)**



SGQ N° 049A

Membro degli Accordi di Mutuo Riconoscimento  
EA, IAF e ILAC  
Signatory of EA, IAF and ILAC Mutual  
Recognition Agreements

Per l'Organismo di Certificazione  
For the Certification Body  
**TÜV Italia S.r.l.**

Validità / Validity

Dal / From: **2019-03-19**

Ai / To: **2022-03-02**

Data emissione / Issuing Date

  
**Andrea Coscia**  
Direttore Divisione Business Assurance **2019-03-19**

**PRIMA CERTIFICAZIONE / FIRST CERTIFICATION: 2001-07-20**  
DATA DI SCADENZA DELL'ULTIMO CICLO DI CERTIFICAZIONE: 2019-03-02  
EXPIRATION DATE OF THE LAST CERTIFICATION CYCLE: 2019-03-02

"LA VALIDITÀ DEL PRESENTE CERTIFICATO È SUBORDINATA A SORVEGLIANZA PERIODICA A 12 MESI E AL RIESAME COMPLETO DEL SISTEMA DI GESTIONE AZIENDALE CON PERIODICITÀ TRIENNALE"  
"THE VALIDITY OF THE PRESENT CERTIFICATE DEPENDS ON THE ANNUAL SURVEILLANCE EVERY 12 MONTHS AND ON THE COMPLETE REVIEW OF COMPANY'S MANAGEMENT SYSTEM AFTER THREE-YEARS"

TÜV Italia S.r.l. • Gruppo TÜV SÜD • Via Carducci 125, Pal. 23 • 20099 Sesto San Giovanni (MI) • Italia • www.tuv.it TÜV®

T01-1481

